

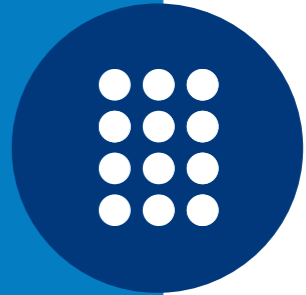

**Electronic
Locks**

SECURITY TECHNOLOGY CONFIDENCE EXPERIENCE QUALITY SERVICE



**Electronic
Locks**

MF SERVICES

contact@mfservices.ie
0214348996

www.mfservices.ie

MF SERVICES



**Electronic
Locks**





technologies for managing access control

The OMNITEC range of locks and access control systems guarantees the levels of security, both mechanically and electronically, required in hotels and the hospitality sector. Establishments that secure access with OMNITEC devices make their guests feel at home.

think forward

The quality that ensures your customer satisfaction

OMNITEC SYSTEMS has accumulated an experience of more than 25 years developing, manufacturing and commercializing Electronic Locks, Safes and Minibars. Today, OMNITEC is one of the most recognized brands in the HOSPITALITY sector, with a guarantee of quality and service on the 5 continents.

A highly specialized team in all areas and a totally market-oriented focus have made it possible for OMNITEC SYSTEMS to develop solutions for security and comfort. By connecting this team with the logistics centres in Europe, America and Asia, today we are able to be present in more than 10,000 hotels around the world, including the most prestigious international hotel chains.

Leaps in quality and specialization do not occur by chance. Recent investments in R+D, guaranteed by our knowledge of the market, have led to OMNITEC SYSTEMS being at the forefront of the sector today.

OMNITEC locks and access control for hotels are the result of our company's specialization and orientation in a single direction - the hotel. Today, our name is synonymous with quality, reliability, security and service, with the best quality/cost ratio on the market.

Electronic Locks

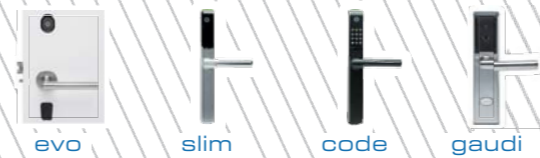

Electronic Cylinders



Access Control



Lockers | Energy Saving



Opening Modes

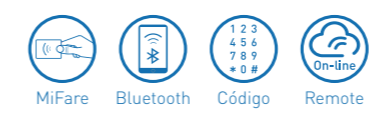

Management Systems Software and Apps



On-line Connectivity



EVO electronic lock

Design technology and innovation converge in EVO to provide an electronic hotel lock of high-performance. EVO incorporates an innovative access control technology, developed by DMNITEC, which allows hotels to implement an unprecedented level of security and control.



INNOVATION

Its minimalist and customizable design, and the opening and management via APP, make EVO a lock with unprecedented features

customize the lock design

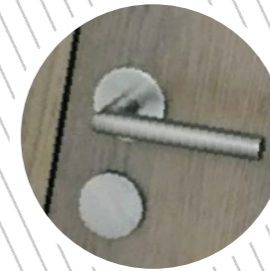

- **Minimalist**, thanks to its avant-garde and innovative design.
- **Customisable Design**, designed for new doors, with a configuration allowing a free choice of handle, with all mechanisms, electronics and batteries installed hidden inside the door, a reader and customisable keyholes.
- **Unlimited Audit Trail**, openings, opening attempts, exits, etc. Audit synchronized with the front desk PC.
- **Bluetooth**, for guest openings, setting up, management and maintenance of the lock.
- **On-Line**, remote opening and management by including Gateways in the installation.
- **Control**, installing in a room the EVO lock, the EXO safe and the Gateway allows remote management and control of both devices.

features

- System of opening with Smartphone via Bluetooth and MIFARE proximity.
- Option to open and manage online by installing Gateways.
- Electronics integrated into the door, without antennas or external connectors exposed to undesired tampering.
- Closing with a latch and privacy activated by a knob.
- Guaranteed operation in the most adverse climatological environments. Stainless steel AISI 304 manufactured. IP 56.
- Visual and acoustic indicators to facilitate their use by disabled persons, as well as for additional functionalities such as low battery warnings to personnel, privacy indicator, etc.
- Mortise with silent latch, anti-card device and anti-panic function.
- Hidden mechanical cylinder, for auditable emergency openings.
- Single app for administrator, hotel staff and guests. UpKey allows different functionalities according to the registered user profile.
- The guest is automatically logged into the app via a link created by the hotel which the guest receives in an email.
- Customised app option and integration with third parties.

electronic lock OS SLIM | CODE

The OS SLIM electronic lock stands out for its slim design with narrow escutcheons that give the door and the room a plus of style and elegance.

Opening by proximity, numerical code, Bluetooth and remote online

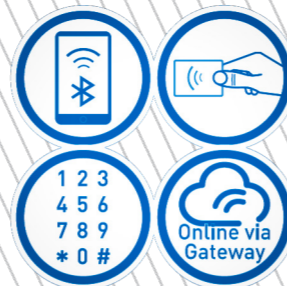

DESIGN

Lock with slim design escutcheon, straight lines, narrow profile and minimalist concept



CORRIDOR



ROOM

MANAGEMENT AND ACCESS APPs



DIMENSIONS

38 x 300 mm



FINISHES

Inox, Black Edition
Gold, Bronze



STRENGTH

Stainless steel AISI 304 or
316 IP54 Optional

- Design, slim profile escutcheon, with narrow and straight lines for a minimalist aesthetic.
- Bluetooth, for guest openings, setting up, management and maintenance of the lock.
- On-Line, remote opening and management by including Gateways in the installation.
- Unlimited Audit Trail, openings, opening attempts, exits, etc. Audit synchronized with the front desk PC.
- Control, installing in a room the OS SLIM lock, the EXO safe and the Gateway allows remote management and control of both devices. Compatible with the GUEST-PRESENCE security function of the EXO safe.

electronic locks

Solutions for hotels of all types

As a result of the experience applied to electronic locks, OMNITEC makes these lock models with proximity opening available for hotels.

GAUDI

Reliable, robust and easy to install. Specially designed for Hotels, Offices and Residences, **GAUDI** integrates all security features into a single reliable and efficient device.

The electronic lock with the best quality/price ratio on the market.



- MiFare proximity opening.
- Free Turn: the lever operates freely but only unlocks the door when a valid card is shown
- Mortise with silent latch and anti-card device, to prevent forced entry.

FIT-IN

Upgrading from keys, magnetic band, chip or RFID locks is quick and easy with **FIT-IN** lock.

Maintaining the existing door locks, **FIT-IN adapts to its installation** and provides the convenience and security of MiFare electronic locks:



- MiFare proximity opening.
- **FIT-IN** lets you replace magnetic card, chip or RFID locks while retaining the existing door lock.

features

- System of opening with MIFARE proximity card 13.56 Mhz
- Anti-panic function to guarantee emergency exits
- Guaranteed operation in the most adverse climatological environments, thanks to its manufacture of stainless steel AISI 304 and its tropicalized electronics
- Visual and acoustic indicators to facilitate their use by disabled persons, as well as for additional functionalities such as low battery warnings to personnel, privacy indicator, etc.
- Electromechanical privacy function with exterior visual indicator to prevent entries of unauthorized persons
- Includes non-volatile EPROM which even when batteries are changed, allows the conservation of the last 400 openings, with information of user, date and time
- Hidden mechanical cylinder, for auditable emergency openings
- Operates with 4 standard AA batteries with duration of up to 20,000 openings
- Configuration and auditing of the locks with wireless control unit
- GAUDI with EURO mortise as standard. ANSI mortise available with fixed handle

FIT-IN SYSTEM

The lock that adapts.

With the incorporation of a new system of plates and levers, OMNITEC makes it possible to maintain existing mortise locks and enjoy all the functionalities of the proximity electronic lock.

FIT-IN complements the traditional key system, equipping it with proximity access control functions. It likewise allows updating of the obsolete and insecure magnetic band, chip or RFID systems.





electronic lock OS SLIM | CODE

features

- Opening via Bluetooth, MiFare proximity, and numerical code (in OS SLIM CODE model).
- Option to open and manage online by installing Gateways.
- Code and Electronic Key with validity adapted to the reservation type: temporary, by time slot, for a single opening, permanent or cyclical.
- Escutcheon with adaptable handle, for doors of left or right opening.
- PVD (Phase Vapour Deposition) lacquered colors, with greater resistance to abrasion and corrosion.
- Guaranteed operation in the most adverse climatological environments. Stainless steel AISI 304 or AISI 316 manufactured. IP54 optional.
- Electromechanical privacy function with exterior visual indicator to prevent entries of unauthorized persons.
- Hidden mechanical cylinder, for auditable emergency openings, and micro USB type C connector for power in case of depleted batteries. Both hidden and protected with a rubber cap.
- Visual and acoustic indicators to facilitate their use by disabled persons, as well as for additional functionalities such as low battery warnings to personnel, privacy indicator, etc.
- Single app for administrator, hotel staff and guests. UpKey allows different functionalities according to the registered user profile.
- The guest is automatically logged into the app via a link created by the hotel, which the guest receives in an email.
- Customised app option and integration with third parties.

connectivity

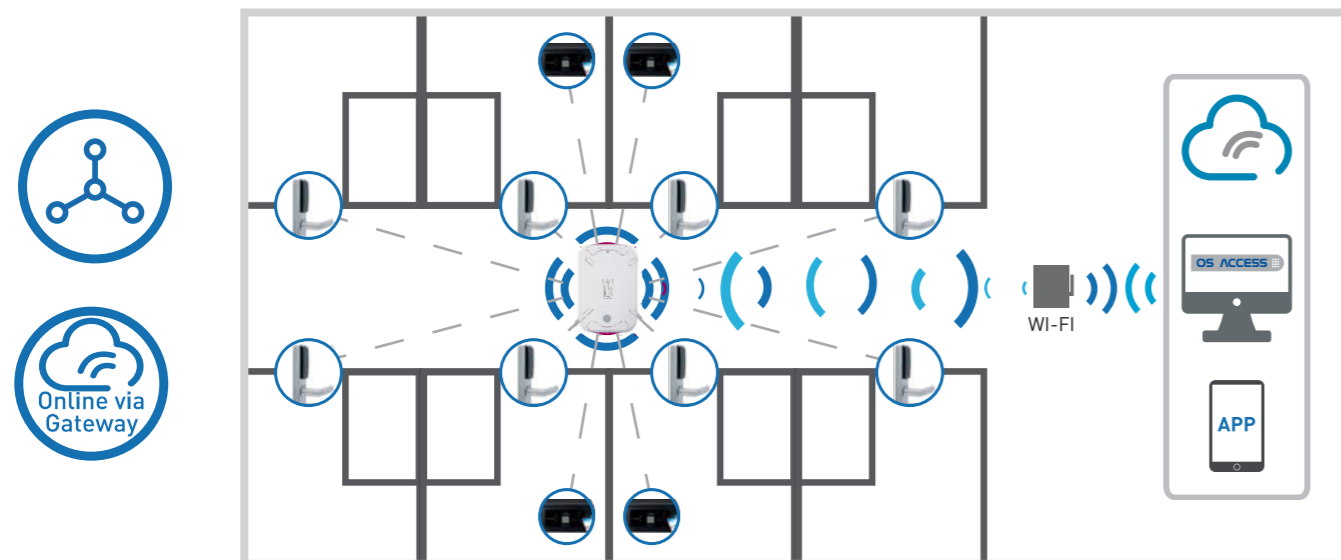

Remote opening & management, including Gateways in the installation

finishes



A SOLUTION FOR EVERY NEED



X-RP2 electronic cylinder

The OMNITEC Electronic Cylinder is the best option for modernizing doors with mechanical lock, which gives a modern and state-of-the-art dimension to the room, whether hotel or office.

OMNITEC's X-RP2 is a quick-installation electronic cylinder, without needing to modify the door.

X-RP2 allows opening with a smartphone via Bluetooth, a proximity card, remotely through connectivity via a gateway, and with numeric code, associating it to a FreePad keyboard.

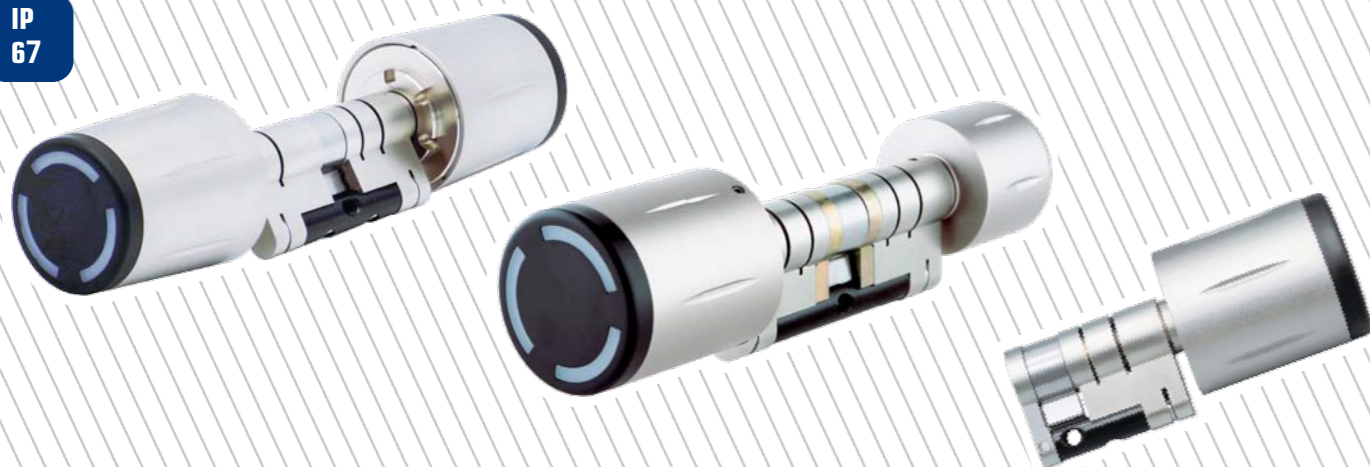
IP
67

features

- European profile cylinder lock, simplifies and speeds up installation.
- Start-up settings via mobile app. Event audit and battery management via mobile app and remotely.
- Connectivity via gateway for online functions.
- Cylinder extendable in increments of 5 and 10 mm. Fits doors of 35-100 mm thickness.
- Operated by 2 CR2 lithium batteries, with a useful life of over 30,000 cycles.
- When changing the batteries, the cylinder lock does not have to be removed.
- Low battery alert and easy battery change.
- Very wide range of working temperatures: -25°C to 65°C.
- Protection class IP67.
- Anti-drill and anti-snap protection (reinforced bridge).

opening options

- Opening via MiFare proximity and via Bluetooth as standard.
- Numeric code: associating the electronic cylinder to a FreePad keyboard.
- Remotely: by online connectivity via a gateway

wireless keypad FreePad

Wireless keypad for linking to Bluetooth devices without a built-in keypad.

Keypad for opening electronic cylinder locks, access controls and Bluetooth locks by numerical code.

FreePad is an additional wireless keypad, so you can open Bluetooth devices with a numerical code without having an integrated keypad.

The FreePad keypad provides pin code opening for the X-RP2 electronic cylinder, the Opak access control and all the bluetooth locks for doors and lockers.

Keypad with standalone configuration, no wires or installation required, beyond attaching it to the wall.

To combat vandalism or theft of the keypad, the OMNITEC system lets you associate another keypad to the device to continue the operation without affecting the access codes of guests or staff.



security

- Vandal-resistant device: tampering with cables or the FreePad keypad PCB does not open the linked device
- 1-to-1 link: one keypad for one device
- Anti-spy numerical code: supports up to 16 digits, including the opening code

features

- Low battery warning
- Dimensions: 96 x 68 x 30 mm
- Connectivity: Bluetooth
- Power: 4 x AAA batteries

Access Controls

OMNITEC offers a range of access controls, for indoor or outdoor use, that are easy to install, with the possibility of providing them with online functionalities to increase **users' security and control**.



MINI MODEL

Discreet, elegant and functional

MiFare card reader and control unit integrated into a single device of easy installation. Its size and design allow it to be integrated into any hotel environment, and control both main doors and areas with restricted access to guests.

- Dimensions: 110 x 42 x 22 mm



ANTI-VANDALISM MODEL

The OMNITEC wall reader Anti-Vandalism access control **is a guarantee of maximum security** in access control. With the independent reader unit and control unit, undesired entries are prevented, due to the impossibility of tampering with the controller. The additional security is provided by the location of the access control unit, which is installed in a controlled zone by own personnel, distant from the reader unit. With this structure, no one from outside the hotel or the company can tamper with the control unit. A control unit manages 2 relays with 2 wall readers by relay simultaneously and has a 12V battery integrated to guarantee the continuity of operation of the system in the event of possible electrical power cuts.

- Dimensions: 111 x 93 x 40 mm



INUP MODEL

Access control and access permission revalidator.

Reads and updates any MiFare proximity device, such as a card, key chain or bracelet.

Its network cable connectivity means it can be installed in main access doors, for personnel access and changing rooms, for example, by managing access credential updates for each user.

In the same operation, users access the restricted area and update their access permissions.

- Front section in high impact resistance polycarbonate.
- IP65 certificate
- Dimensions: 76 x 121 x 51 mm



DIGIT MODEL

Range of access controls with opening by numeric keypad, proximity card, Bluetooth and online, for doors with an electronic latch, garage doors and parking barriers, for example.

In hotels with EVO, SLIM or GAUDI BLE locks, guests can access direct to their room via their Smartphone or by using a PIN code.

- 2 models with different opening modes:
 - Proximity card, Bluetooth or online, connected via Gateway.
 - PIN code, proximity card, Bluetooth and online, connected via Gateway
- 1 output relay
- Dimensions: 124 x 78 x 16 mm



OPAK MODEL

Access control with Bluetooth and online opening to control doors equipped with an electrical latch, garages, turnstiles, automatic gates and front doors connecting the device to the automatic entry system.

Its small size means it goes unnoticed and allows it to be installed in hidden or inaccessible areas so as not to demonstrate the presence of the automation devices.

- Opening via Bluetooth and online
- 1 output relay
- Dimensions: 63 x 32 x 22 mm

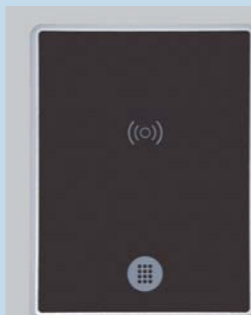

LIFT CONTROL MODEL

The OMNITEC control has been designed to integrate into the management panels of the lift and increase the security of your hotel.

With the lift control, the guest can only access where you have granted him permissions on the MiFare card or on the Bluetooth e-key.

With the pertinent credentials, the hotel will be able to limit the general use of the lift or even limit access to specific floors.

With a modern and minimized design, it is installed with minimal intervention in the lift panel.

- Dimensions: 60 x 80 x 7,5 mm



GATEWAY ON-LINE connectivity

The OMNITEC Gateway converts Bluetooth electronic locks and Bluetooth access controls into online devices.

operation

The online OMNITEC system operates by double connectivity: Bluetooth and **WiFi / PoE / 4G**.

Devices > Administrator

Electronic locks and access controls send the information via Bluetooth to the Gateway. The Gateway, through a network with internet connection, sends all the information received to the server to make it available for the administrator.

Administrator > Devices

The online functions the administrator executes remotely from their PC or Smartphone are transmitted from the server to the Gateway via Wi-Fi, and channelled via Bluetooth to the locks, access controls and safes.

When the administrator Smartphone and the lock or access control to be managed are within the Bluetooth range, they communicate directly via Bluetooth and transmit the information without using the Gateway or Wi-Fi.

To implement an online system, a Wi-Fi network, locks, access controls and/or safes with Bluetooth connectivity from OMNITEC are essential.

on-line functions

- Audit trail
- Remote opening from Front-Desk or via administrator smartphone
- Battery level control
- Access credential management
- Date / Time update

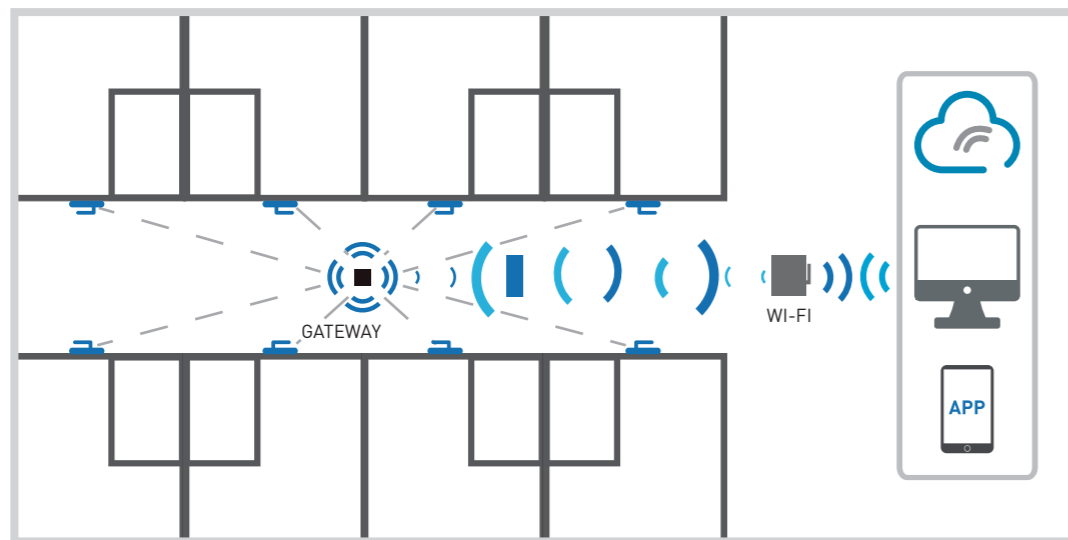

GATEWAY WiFi



With an online connection via Wi-Fi, the locks and access controls transfer the recorded events to the Cloud, through the Gateway, and devices can be managed remotely.

features

- Bluetooth range: up to 10m
- Power: 5V/500mA DC
- IEEE standard: 802.11 b/g/n
- Connection: USB Type C
- Network: 2.4G Wi-Fi
- Dimensions: 70 x 104 x 18 mm

GATEWAY PoE



The Gateway PoE shares all the functions and operational ability of the Gateway WiFi. In this model there is a different method of connection with the router, which connects via a RJ45 cable.

The cable provides network connection and electric power to the gateway, allowing simpler and stabler installations.

Requires the router/server to be PoE in order to supply power to the gateway.

features

- Power: 5V/500mA DC
- Network: Ethernet-RJ45
- Dimensions: 70 x 70 x 26 mm
- Connection: USB Type C

GATEWAY 4G



Designed for premises in remote areas without a router/server connection. The 4G Gateway uses a SIM card to communicate with a server via 4G connection to send all the information from locks in real time.

features

- Bluetooth range: up to 10m
- Dimensions: 110 x 110 x 36 mm
- Connection: Micro USB
- Power: 5V/500mA DC
- Network: 4G

locks for Lockers

OMNITEC offers a **simple, practical and secure** locker management system with the range of electronic locks.

OMNITEC electronic locks for lockers are the ideal solution for keeping the belongings of users and employees of health centers, spas, gyms, sports centers, education centers, company dressing rooms, etc. as well as in the usually shared room closets of hostels.



LOCKERFY

Electronic lock for lockers with Bluetooth, proximity card and code opening.

Electronic lock for lockers, drawers and furniture. Simple and fast installation in lockers, cabinets, drawers, etc. Suitable for installation on all types of materials. Online connexion through Gateway, allows the administrator to manage users, openings log audit and remote opening from its Smartphone.

Two different modes of operation:

- Auto-closing, with programmable closing time.
- Open mode: the user closes the lock with their bluetooth electronic key, code or card.

Distinguish between 2 user modes:

- Owner: for lockers exclusively used by one person.
- Allocation: the user uses the free lockers that are available at any given time. 1 card can close only 1 locker.

Programmable automatic opening at a certain time.

Opening alarm: alarm sounds and lights up when forced to open.



E-LOCKER STYLE

Integration with OMNITEC locks, **the same MiFare card for the room and the locker.**

Fast installation in lockers and cabinets made from wood, sheet metal, plastic, phenolic, etc.

Modern, easy and intuitive design for the user. Integrated handle for easier use of the locker.

Allocation: the user uses the free lockers that are available at any given time.



Energy savers

One of the priorities of OMNITEC is its commitment to the environment and to contributing to saving energy in hotels, apart-hotels, residences, universities, public buildings, offices, etc.. The OMNITEC energy savers are devices that allow up to 60% of the electrical consumption of the buildings where they are installed to be saved.



BUILT-IN ENERGY SAVER

Simple: activated with any card.

MiFare: operates exclusively with MiFare cards, without reading credentials.



SMART ENERGY SAVER

Smart: activates the electrical installation with just the room's own MiFare card.

Its two relays are activated, or not, depending on the guest or service credentials.



WIRELESS ENERGY SAVER

Wireless energy savers work in conjunction with the wireless motion, door and window sensors in those facilities where the room is accessed via Smartphone; with all-inclusive wristband, key ring, card, etc.

Wireless energy saver is designed for installation on a DIN rail.

The device is integrated into the lighting panel, simplifying its installation and without interfering with the aesthetics of the room.

features

- Recessed and surface models
- LED indicator
- Available in different colours
- Courtesy light 10 to 30 seconds
- Allows work with automated systems, energy management systems and lighting controls
- Current: 16 A



management software

OMNITEC has developed different management systems to meet the needs of any hotel and simplify the management and control of access credentials for guests and internal and external personnel.

OMNITEC software acts as the backbone in the integrated access plan for hotels, tourist accommodation, residences and the hospitality sector.

OS ACCESS software

OS ACCESS is the most innovative development by OMNITEC that meets the most demanding technical requirements of hotels and can optimise the management of hotel access credentials and security for MiFare proximity, numeric code and Bluetooth devices.

Designed to work in the Cloud from a web browser, **OS ACCESS** also offers a desktop version for a local network.



The **OS ACCESS** software is complemented by the **UpKey app**, used by hotel staff for the installation and management of Bluetooth locks and devices, as well as for access to the different rooms via Smartphone.

Hotel guests receive their keys on their Smartphone and can access the room and the rest of the permitted areas using their own phone.

CLOUD server



Software installed on a secure Cloud server, which users access through a browser without the need to install additional software on their PCs.

Accessibility, security and efficiency in managing access to your hotel.

Opening Alerts



Configures your push notifications for openings and attempted openings of certain locks or devices equipped with Bluetooth.

Online security and access control with special restrictions.

Remote Management



Performing remote daily tasks such as managing guest and employee credentials, opening records, maintenance and emergency openings are possible through connectivity via Gateways.

Fast Check-In



Quick procedure for creating guest cards with just 2 pieces of data. MiFare cards, numeric codes and Bluetooth keys can be created quickly to streamline the guest check-in process.

Staff Credentials



Establishing employee profiles streamlines and minimises the management of the hotel's access plan.

Permission changes are updated for all profile members.

Specific access permissions are granted for users who do not fit into any profile.

OMNI UX



Modern design with an intuitive interface, made especially with the user experience in mind.

OS ACCESS OMNI UX usability allows the hotel to save time in its processes and personnel training.



OS ACCESS software

Cloud Server ADVANTAGES

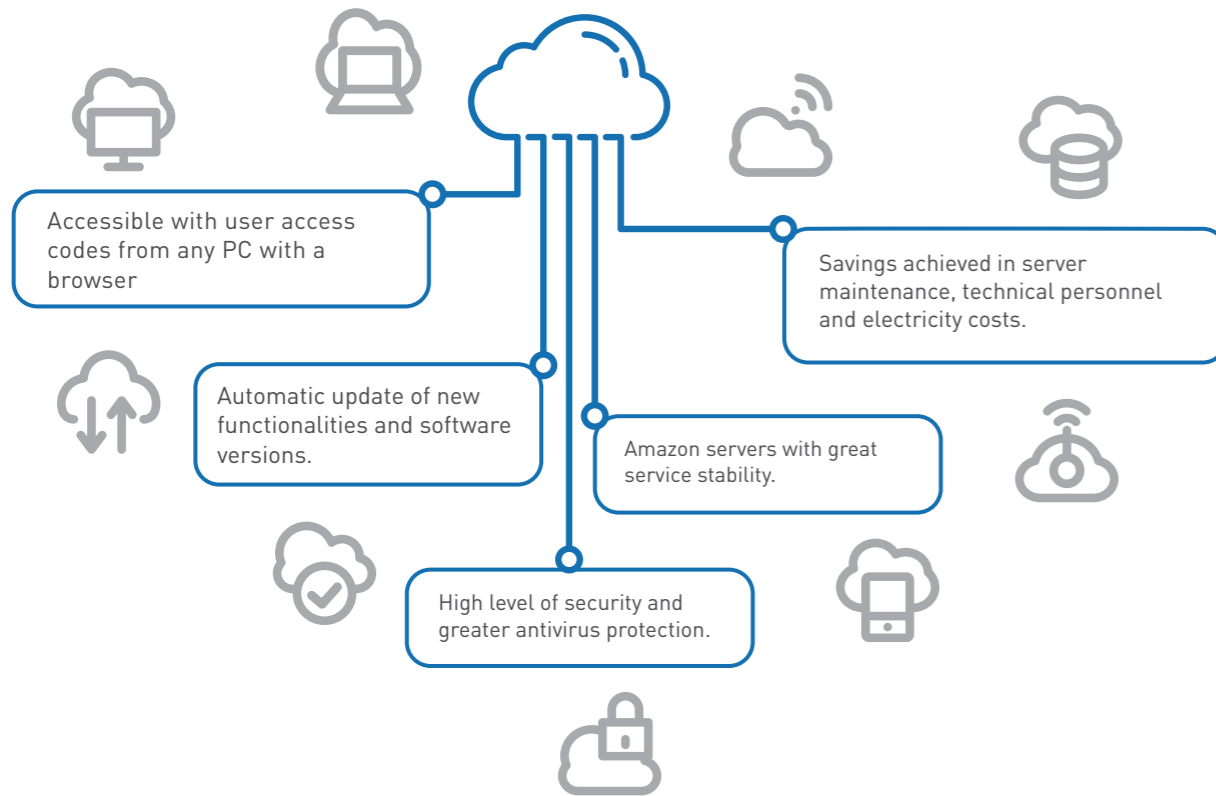

Features

- **Access by browser** optimises the availability, security and efficiency of the system
- **Encrypted data recording** on identification media
- Multi-user **license** valid for use under a Windows environment
- Secure SQL **database** notably increasing security and providing secure access for remote technical assistance
- **Integration** with any PMS on the market (Opera, Prestige, etc.), and with room management systems
- Uniquely coded card encoding per installation or group of installations, limiting the use of cards that are not coded by the authorized devices
- Different levels of access for different system users
- **MOTEL Option**, limiting the use of the lock by hours
- **Scalable**: the platform gradually adjusts to the facilities, depending on the size of the access plan, the diversity of installed devices and user profiles. Users manage only those functionalities required in their facilities, allowing them to optimise their daily work

VANGUARD

Maximum operability and efficiency for hotels, guests and employees



online connectivity

The incorporation of the DMNITEC Gateway into the hotel infrastructure converts Bluetooth electronic locks into online devices.

Having an online connection, the Bluetooth locks, safes, cylinders, access controls, etc. transfer all recorded events to the Cloud and can be managed remotely.

features

- Online Audit Trail
- Remote opening from Front-Desk or via administrator smartphone
- Battery level control
- Access credential management
- Date / Time update
- Opening alerts



UpKey app

The OMNITEC **UpKey** app works in addition to the **Os Access** software in hotel access management.

UpKey turns your Smartphone into an access key, programmer command for installation and maintenance, and a remote integrated management platform for the access plan.

The combination of **Os Access** software, **UpKey** app and Gateways gives the hotel a multitude of possibilities in managing the access plan, both in person and remotely, and provides an immediate response under any circumstances.

Absolute control and management

For safer access management at the hotel, **UpKey** works under 3 user profiles:

Guest

You can access your room, garage, spa, etc. and open the safe with your Smartphone after receiving the corresponding eKeys.

Employee

You have access credentials for you to open and perform daily maintenance on all devices for which you have active credentials.

Once the commissioning of the facility is complete, control of locks, access control and safes are transferred to the administrator.

Administrator

For full control of the hotel's access plan; controls and manages all devices and access credentials for the entire facility, for both employees and guests.

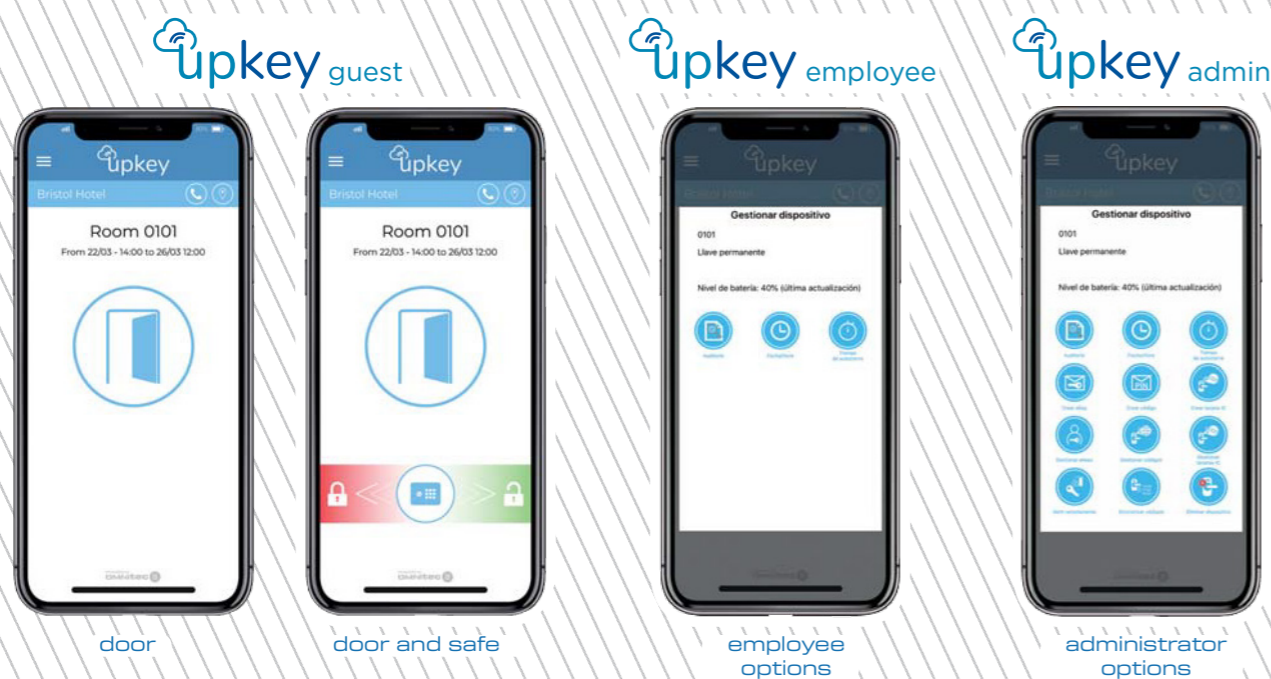

CONNECTIVITY

Ongoing control of the access plan from anywhere



administration main functions

- Opening record**
Lists all openings and attempted openings
- Create eKey**
Establishes and sends Bluetooth keys
- Manage eKeys**
Manages and cancels active eKeys
- Open Remotely**
Remote opening through Gateway. Requires double validation
- Delete device**
Unlinks the user's device and puts it into installation mode
- Date/Time**
Updates the device date and time
- Create Code**
Establishes and sends numerical opening codes
- Manage Codes**
Manages and cancels numerical codes
- Synchronise codes**
Updates active code credentials on a device
- Wireless Keypad**
Pair a wireless keypad to the Bluetooth device
- Restore Settings**
Update the software configuration to the lock
- Create Card**
Sends the proximity card credentials to the device
- Manage Cards**
Manages and cancels active proximity cards
- Passage Mode**
Set the opening and auto-closing time. In that time frame, it keeps open fixed
- Set Meeting Mode**
Cancel the auto-close time. Opening and closing from the APP

SMARTPASS software

At OMNITEC, we have developed **SMARTPASS** software to manage electronic proximity locks, access control and energy savers. Management with the **SMARTPASS** software is complemented by the wireless programming controller and MiFare programming cards. **SMARTPASS** was designed to meet the needs and demands of any type of hotel establishment, **guaranteeing internal security and control.**



IDENTIFICATION TECHNOLOGY

MIFARE PROXIMITY (13.56 Mhz)

OMNITEC locks use the **MIFARE** (13.56 Mhz) identification system, the most widely-used, and at the same time, the most secure technology, allowing very simple and quick integration with other market applications.

The medium on which the access credential is held can have multiple formats, and always adapted to the needs of the hotel: cards, key holders, bracelets, all-inclusive bracelets, etc. These can all be carried openly and don't confine the user, which finally translates into significant cost savings.



SECURITY | CONTROL | PEACE OF MIND

SMARTPASS SOFTWARE

Of the different systems that **SMARTPASS** encompasses, the most common one and with highest level of implementation at the international level is the management software, which offers:

- **Encrypted recording** of data on identification supports
- Multi-user **license** valid for use under a Windows environment
- Secure SQL **database**, notably increasing security and providing secure access for remote technical assistance. Optional installation on **OMNITEC Server**
- **Compatible** with any PMS on the market (Opera, Prestige, etc.)
- Uniquely coded card encoding per installation or group of installations, limiting the use of cards that are not coded by the authorized devices
- Different levels of access for different system users
- Management and control of guests and employees access
- **BackUp System** in order to issue new credentials for new guests in case of computer problems
- **HOSTEL Option**, for shared use of rooms by different guests, with independent check-in and check-out dates
- **MOTEL Option**, limiting the use of the lock by hours
- Direct access to the online assistance website
- **REVALIDATOR**: our system is capable of managing credentials by the hour or day/s. After the indicated period, it is necessary to revalidate their user permissions with the **OMNITEC Revalidator** in order for the card to continue to be operational. The device can be installed in a door or controlled passage by which, at the same time it revalidates the user permissions, it grants access to the user, speeding up and securing the process and the security of the hotel to the utmost





Rent & Pass app

The OMNITEC **Rent & Pass** app has been developed for access management in all establishments that do not require server software such as **Os Access** or **SmartPass**, owing to their size.

Small hotels, hotels without a 24-hour Reception, rural tourism accommodation, boutique hotels, etc. You will find the management and maintenance tool in **Rent&Pass** that best suits your business; offering remote management from a smartphone or tablet.

ELECTRONIC KEY

Sending electronic keys via an app anywhere and anytime



NUMERICAL ACCESS CODE

Opening via numerical code without installing an app



REAL-TIME MANAGEMENT

Remote cancellation, blocking and deleting keys sent at any time



AUDITABLE ACCESS

Access logging for each lock and user



ACCESS CODE MANAGEMENT

Code with custom properties, it can be deleted at any time

3XAX2
5BA5B
2A2A2
85BG9

ALERT FUNCTION

Notification of alerts in real time, security and protection

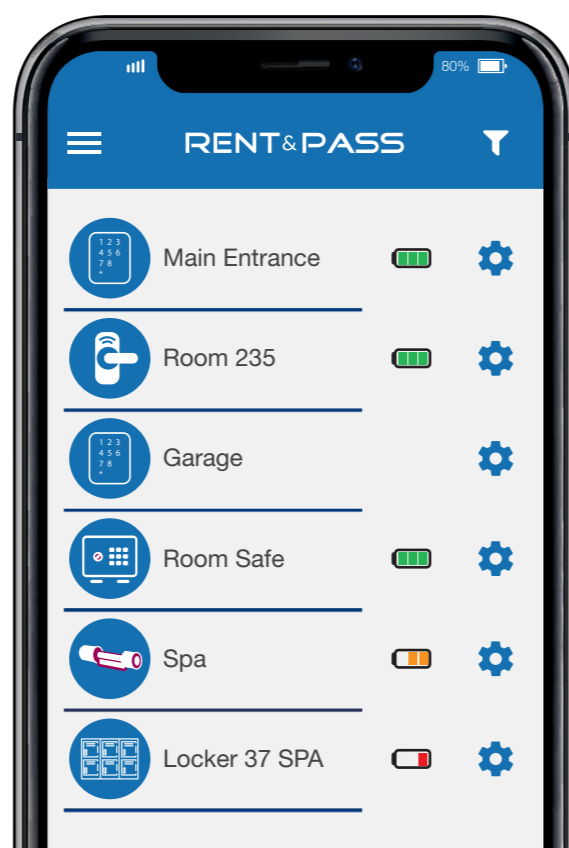

OPERATION

Convenience and simplicity when managing access to your hotel

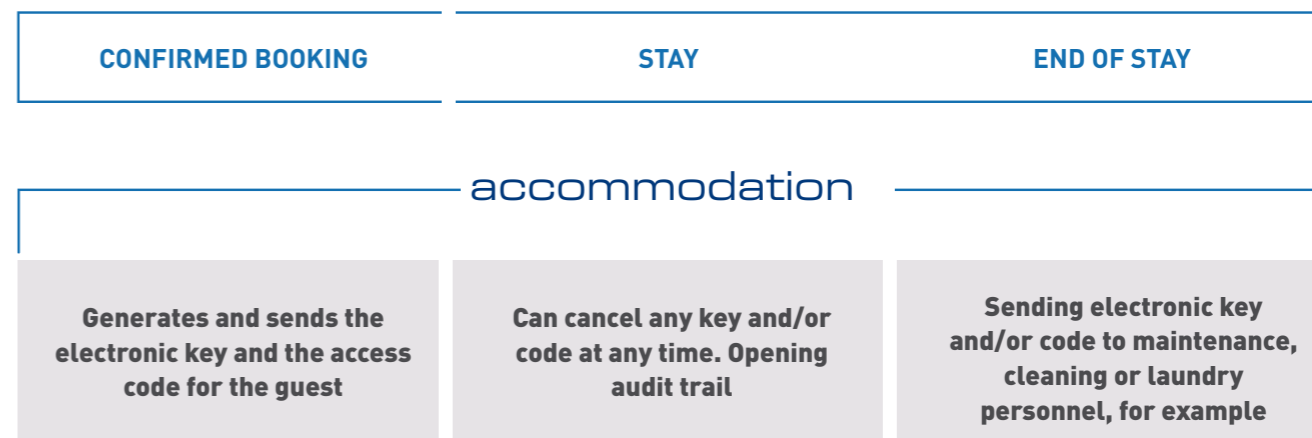

security and control

Rent&Pass lets the owner and hotel staff send the guest electronic keys and numerical codes to access the hotel, the room, the garage and any other room equipped with an OMNITEC Bluetooth access control. With **Rent&Pass** you can cancel and delete Bluetooth keys and numeric codes at any time from the app with administration permissions.

Rent&Pass incorporates notifications to the hotel when the guest opens any device.

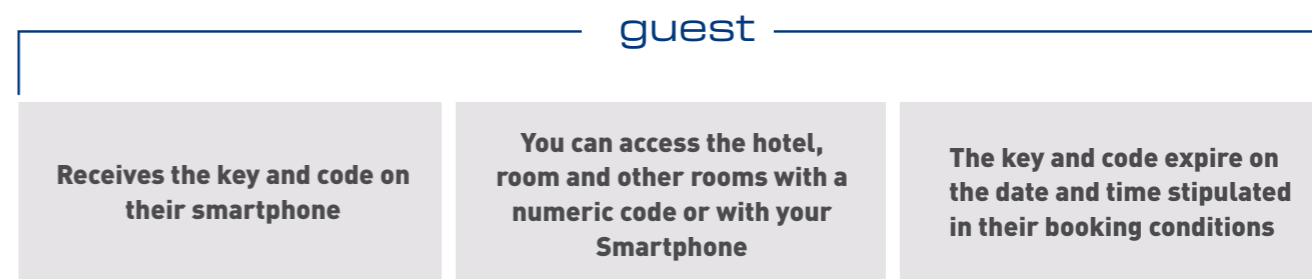

simple procedures, satisfied guests

With **Rent&Pass**, your arrival time and unexpected delays no longer matter. Before starting their trip, guests receive the following on their Smartphone: electronic key and/or access codes for locks, access control for the main hotel entrance, as well as their room, garage and any other area equipped with an access control system.

app Rent & Pass PRO

Rent&Pass has a **PRO** version, developed for all those owners who want to carry out more advanced management in their establishments.

In addition to all the normal **Rent&Pass** functions, the **PRO** version incorporates:

- **Check-In:** For the registration of users/guests, with start/end times and dates, and a **rapid assignment of devices for which credentials are granted.**
- **Calendar:** Displays user credentials in a day/week calendar format with **direct access to Check-In to expedite management tasks.**
- **Staff:** For management of staff credentials. In addition to start/end times and date access management, staff can be given permanent access or **classified according to their different user profiles and roles.**

		MANAGEMENT			OPENING		
		OS ACCESS Upkey	Server SMARTPASS	RENT PASS	CARD	Bluetooth	CODE
 EVO		•		•	•	•	
 SLIM		•	•	•	•	•	
 SLIM CODE		•	•	•	•	•	•
 GAUDI FIT-IN		•	•		•		
 X-RP2		•		•	•	•	
 MINI		•	•		•		
 ANTI-VANDALISM		•	•		•		
 INUP		•	•		•		
 DIGIT		•	•	•	•	•	•
 OPAK		•	•	•		•	
 LIFT		•	•	•	•	•	